



FEATURES

Powered by CentriPro 4" motors for dependable operation and long service life.

Nylon discharge head features built-in, o-ring seal check valve which is easily removed without pump disassembly.

Nylon motor adapter for strength and corrosion resistance.

Stainless steel hex design shafts, shaft couplings, casings and stage bowls inhibit corrosion.

Noryl® engineered composite impellers for abrasion resistance and durability.

Lexan® engineered composite diffusers are abrasion resistant.

All engineered composite components are non-toxic, non-leaching, FDA compliant materials.

Goulds Water Technology field proven floating impeller stack design for superior sand and abrasive handling and durability.

Quad Lock Technology: 4 Roll Formed grooves provide durability and strength, tested to exceed strength of poly and PVC pipes.

Complete pump/motor assemblies are CSA listed, CSA/CUS approved motors are available in 2-wire and 3-wire single phase designs.



HS

60 HZ STANDARD CAPACITY 4" SUBMERSIBLE PUMPS

WATER END DATA

Model	Order No.	Req. HP	Stages	Weight (lbs)	Length (in)
5HS	5HS05	½	12	5.5	15.3
	5HS07	¾	15	6.5	17.3
	5HS10	1	20	8.1	20.8
7HS	7HS05	½	10	4.9	14.1
	7HS07	¾	13	5.9	16.3
	7HS10	1	17	7.2	19.1
10HS	10HS05	½	7	3.9	11.8
	10HS07	¾	10	4.9	13.9
	10HS10	1	12	5.5	15.3
	10HS15	1½	17	7.2	18.7
18HS	18HS07	¾	6	3.8	12.1
	18HS10	1	8	4.5	13.8
	18HS15	1½	11	5.6	16.4
25HS	25HS10	1	7	4.3	13.6
	25HS15	1½	9	5.1	15.4

MATERIALS OF CONSTRUCTION

Part Name	Material
Discharge Head	Glass Filled Engineered Composite
Check Valve Poppet	Delrin®
Check Valve O-ring	NBR
Bearing	Proprietary Engineered Polymer
Shaft Retaining Ring	AISI 301 SS
Diffuser	Lexan®
Impeller	Noryl®/GFN2
Bowl	AISI 304 SS
Shim	AISI 304 SS
Inlet Strainer	Glass Filled Engineered Composite
Screws - Cable Guard	AISI 304 SS
Motor Adapter	Glass Filled Engineered Composite
Casing	AISI 304 SS
Shaft	
Coupling	AISI 304 SS, Powder Metal
Cable Guard	PVC

NOMENCLATURE

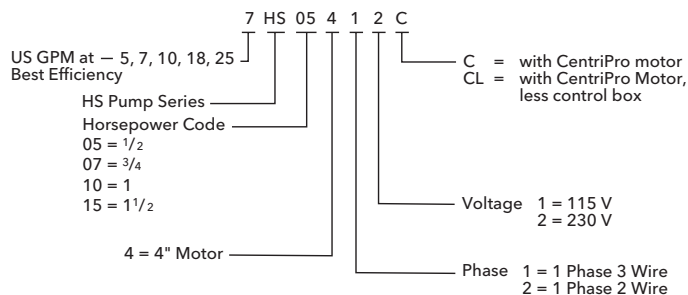

GENERATION II - 2-WIRE & 3-WIRE WEIGHTS AND DIMENSIONS

Type	CentriPro Order No.	HP	Volts	Length (L) In.	Weight (lbs)
2-Wire	M05421	.5	115	10.5	18
	M05422	.5	230	10.5	18
	M07422	.75		11.9	22
	M10422	1		12.5	24
	M15422	1.5		14.2	28
3-wire	M05411	.5	115	9.6	18
	M05412	.5	230	9.2	17
	M07412	.75		10.3	20
	M10412	1		11.2	22
	M15412	1.5		12.8	26
	M20412	2		15.1	31
	M30412	3		18.3	40
	M50412	5		27.7	70

2-WIRE MODELS WITH CENTRIPRO MOTOR

Model	Order No.	HP	Stages	Volts	2-Wire CP
5HS	5HS05421C	½	12	115	M05421
	5HS05422C	½	12	230	M05422
	5HS07422C	¾	15	230	M07422
	5HS10422C	1	20	230	M10422
7HS	7HS05421C	½	10	115	M05421
	7HS05422C	½	10	230	M05422
	7HS07422C	¾	13	230	M07422
	7HS10422C	1	17	230	M10422
10HS	10HS05421C	½	7	115	M05421
	10HS05422C	½	7	230	M05422
	10HS07422C	¾	10	230	M07422
	10HS10422C	1	12	230	M10422
	10HS15422C	1½	17	230	M15422
18HS	18HS07422C	¾	6	230	M07422
	18HS10422C	1	8	230	M10422
	18HS15422C	1½	11	230	M15422
25HS	25HS10422C	1	7	230	M10422
	25HS15422C	1½	9	230	M15422

3-WIRE MODELS WITH CENTRIPRO MOTOR

Model	Order No.	HP	Stages	Volts	3-Wire CP
5HS	5HS05411C	½	12	115	M05411
	5HS05412C	½	12	230	M05412
	5HS07412C	¾	15	230	M07412
	5HS10412C	1	20	230	M10412
7HS	7HS05411C	½	10	115	M05411
	7HS05412C	½	10	230	M05412
	7HS07412C	¾	13	230	M07412
	7HS10412C	1	17	230	M10412
10HS	10HS05411C	½	7	115	M05411
	10HS05412C	½	7	230	M05412
	10HS07412C	¾	10	230	M07412
	10HS10412C	1	12	230	M10412
	10HS15412C	1½	17	230	M15412
18HS	18HS07412C	¾	6	230	M07412
	18HS10412C	1	8	230	M10412
	18HS15412C	1½	11	230	M15412
25HS	25HS10412C	1	7	230	M10412
	25HS15412C	1½	9	230	M15412

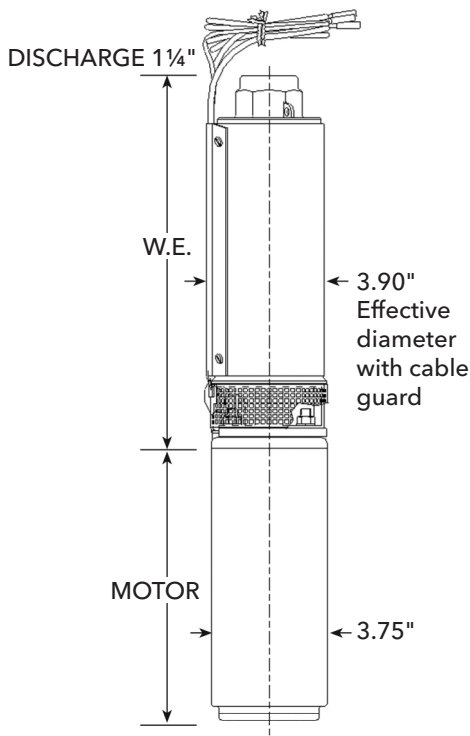

MODEL 10HS

SELECTION CHART

Horsepower Range ½ - 1½, Recommended Range 3 - 16 GPM, 60 Hz, 3450 RPM

Pump Model	HP	PSI	Depth to Water in Feet/Ratings in US GPM (Gallons per Minute)																					
			20	40	60	80	100	120	140	160	180	200	220	240	260	280	300	340	380	420	460	500	540	
10HS05	½	0				16.0	15.3	14.3	12.8	11.3	9.0	6.4												
		20		15.9	14.9	13.8	12.5	10.8	8.3	4.8														
		30	15.7	14.6	13.5	12.3	10.5	7.8	4.0															
		40	14.5	13.4	12.0	10.3	7.5	3.0																
		50	13.0	11.5	9.8	7.2																		
		60	11.3	9.0	6.4																			
Shut-off PSI			89	81	72	63	55	46	37	29	20	11												
10HS07	¾	0				15.8	15.0	14.0	13.0	12.3	11.2	10.2	8.5	6.0										
		20				15.7	14.8	13.9	12.8	12.0	11.0	9.8	8.2	5.5										
		30			15.6	14.7	13.8	12.7	11.9	10.8	9.7	8.1	5.2											
		40	15.3	14.4	13.5	12.6	11.6	10.5	9.4	7.5	4.8													
		50	14.3	13.4	12.5	11.5	10.3	9.0	7.0	4.0														
		60	13.0	12.1	11.3	10.4	9.5	8.7	7.8	6.9	6.1	5.2	4.3	3.5	2.6	1.7	9							
Shut-off PSI			130	121	113	104	95	87	78	69	61	52	43	35	26	17	9							
10HS10	1	0									15.8	15.2	14.5	13.7	12.8	12.0	11.0	10.0	6.7					
		20						15.7	14.9	14.3	13.5	12.7	11.7	10.6	9.6	8.1	6.5							
		30				16.0	15.6	14.8	14.2	13.3	12.5	11.6	10.4	9.4	7.8	5.5	3.0							
		40			16.0	15.5	14.7	14.1	13.2	12.4	11.5	10.3	9.1	7.4	5.0	3.0								
		50			15.3	14.6	13.9	13.0	12.3	11.3	10.1	8.9	7.0	4.3										
		60	15.8	15.2	14.5	13.7	12.8	12.0	11.0	10.0	8.6	6.7	4.0											
Shut-off PSI			158	150	141	132	124	115	106	98	89	81	72	63	55	46	37	20						
10HS15	1½	0												15.7	15.3	14.8	14.4	13.3	12.2	10.9	9.3	7.1	3.0	
		20												16.0	15.6	15.2	14.7	14.3	13.7	13.2	11.9	10.6	9.0	6.5
		30										15.9	15.5	15.2	14.6	14.2	13.5	13.1	12.6	11.3	9.7	7.6	4.0	
		40								15.8	15.5	15.1	14.6	14.2	13.5	13.0	12.5	11.8	10.3	8.8	6.0			
		50						15.7	15.4	14.9	14.5	14.0	13.4	12.8	12.3	11.7	11.0	9.4	7.4	3.4				
		60					15.7	15.3	14.8	14.4	13.9	13.3	12.8	12.2	11.6	10.9	10.1	8.1	5.6					
Shut-off PSI						197	188	180	171	162	154	144	136	128	119	110	93	76	58	41	24	6		

MODEL 18HS

SELECTION CHART

Horsepower Range $\frac{3}{4}$ - $1\frac{1}{2}$, Recommended Range 6 - 28 GPM, 60 Hz, 3450 RPM

Pump Model	HP	PSI	Depth to Water in Feet/Ratings in US GPM (Gallons per Minute)															
			20	40	60	80	100	120	140	160	180	200	220	240	260	280	300	
18HS07	$\frac{3}{4}$	0			28.2	26.5	24.0	21.0	17.9	13.5								
		20	27.7	25.9	23.0	20.0	16.5	10.8										
		30	25.0	22.0	18.8	15.7	9.5											
		40	22.2	18.9	15.1	9.0												
		50	18.4	15.0	7.5													
		60	13.5	5.0														
Shut-off PSI			74	66	58	49	40	32	23	14								
18HS10	1	0					27.0	25.5	23.6	21.2	18.8	15.9	12.0					
		20		28.0	26.6	25.1	22.7	20.0	17.6	14.0	10.0							
		30	27.9	26.1	24.3	22.2	19.8	17.1	13.8	8.3								
		40	26.0	24.1	22.0	19.7	17.0	13.1	8.0									
		50	24.0	22.0	19.1	16.5	13.0	7.1										
		60	21.0	18.6	15.8	12.0												
Shut-off PSI			103	94	86	77	68	60	51	42	34	25	16					
18HS15	$1\frac{1}{2}$	0						28.4	27.2	26.0	24.8	23.0	21.4	19.6	17.5	15.0	12.1	
		20					27.8	26.8	25.4	24.0	22.2	20.6	18.8	16.7	14.0	10.0		
		30				27.7	26.5	25.3	23.8	22.0	20.2	18.5	16.1	13.5	10.0			
		40			27.5	26.3	25.0	23.6	22.0	20.1	18.1	16.0	13.1	9.5				
		50	27.6	26.4	25.0	23.4	21.8	20.0	18.0	15.5	13.0	9.2						
		60	26.0	24.6	23.0	21.2	19.5	17.5	15.0	12.0	7.9							
Shut-off PSI			143	134	126	117	108	100	91	82	74	65	56	48	39	30	22	

MODEL 25HS

SELECTION CHART

Horsepower Range 1, Recommended Range 8 - 33 GPM, 60 Hz, 3450 RPM

Pump Model	HP	PSI	Depth to Water in Feet/Ratings in GPM (Gallons per Minute)												
			20	40	60	80	100	120	140	160	180	200	220	240	260
25HS10	1	0			31.5	29.3	27.2	24.7	22.8	18.9	15.0	10.7			
		20	30.8	29.1	26.7	24.4	21.3	18.4	14.6	7.8					
		30	28.7	26.4	24.3	21.0	17.5	13.6							
		40	26.3	24.2	20.9	17.4	13.5								
		50	23.6	20.4	17.0	12.6									
		60	19.4	15.7	10.7										
Shut-off PSI			80	72	63	54	47	38	29	21	13	4			
25HS15	1½	0				32.0	30.8	29.4	27.9	26.1	24.1	21.3	19.2	16.5	11.0
		20		31.6	30.3	28.7	27.2	25.2	23.1	20.4	17.6	14.4	7.8		
		30	31.5	30.1	28.6	26.8	24.8	22.5	20.3	17.4	13.6				
		40	30.0	28.5	26.7	24.7	22.4	20.2	17.2	13.2					
		50	28.1	26.4	24.3	22.2	19.8	16.7	12.6						
		60	26.1	24.1	21.3	19.2	16.0	10.7							
Shut-off PSI			108	100	91	82	75	66	57	49	41	32	24	16	7

Model 5HS

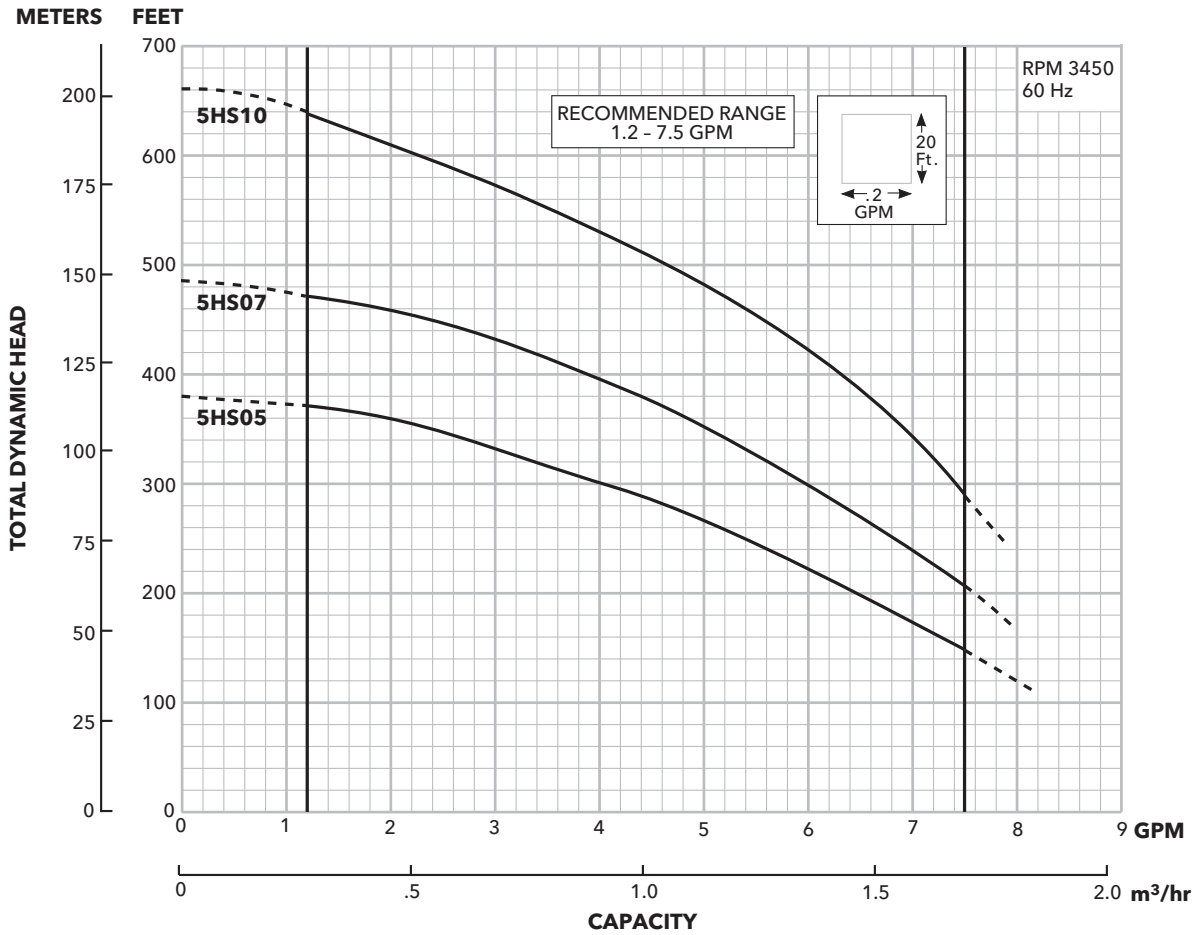

Model 7HS

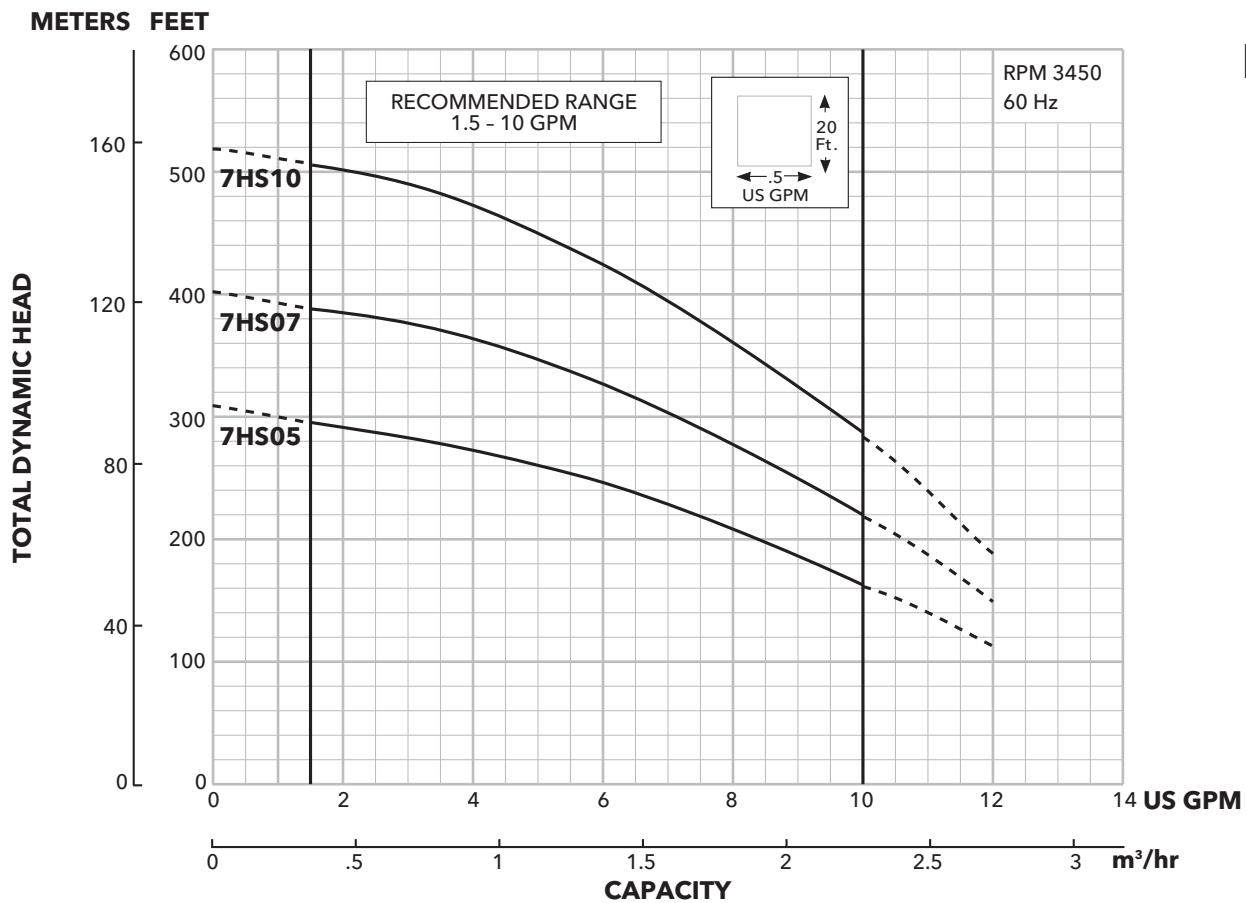

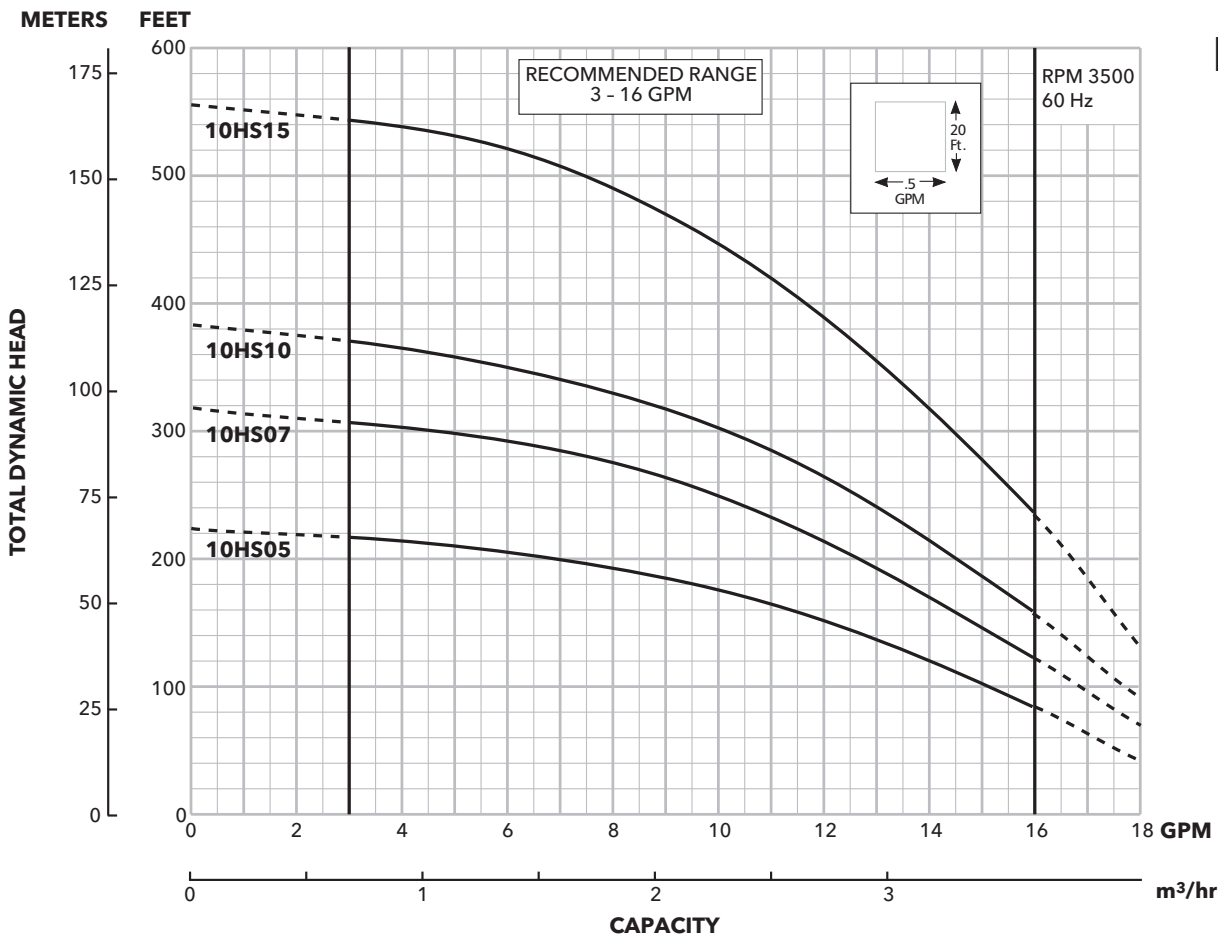

Model 10HS

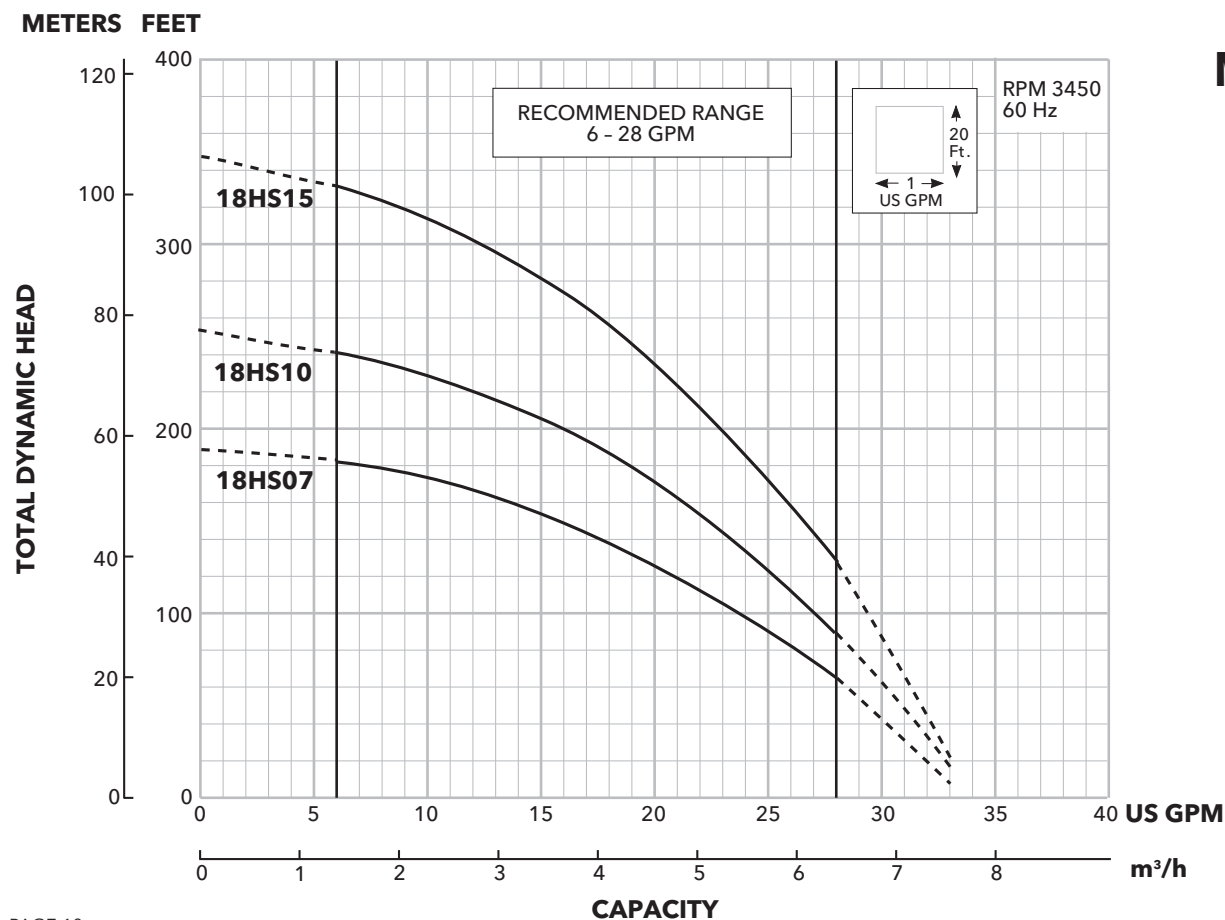

Model 18HS

Model 25HS

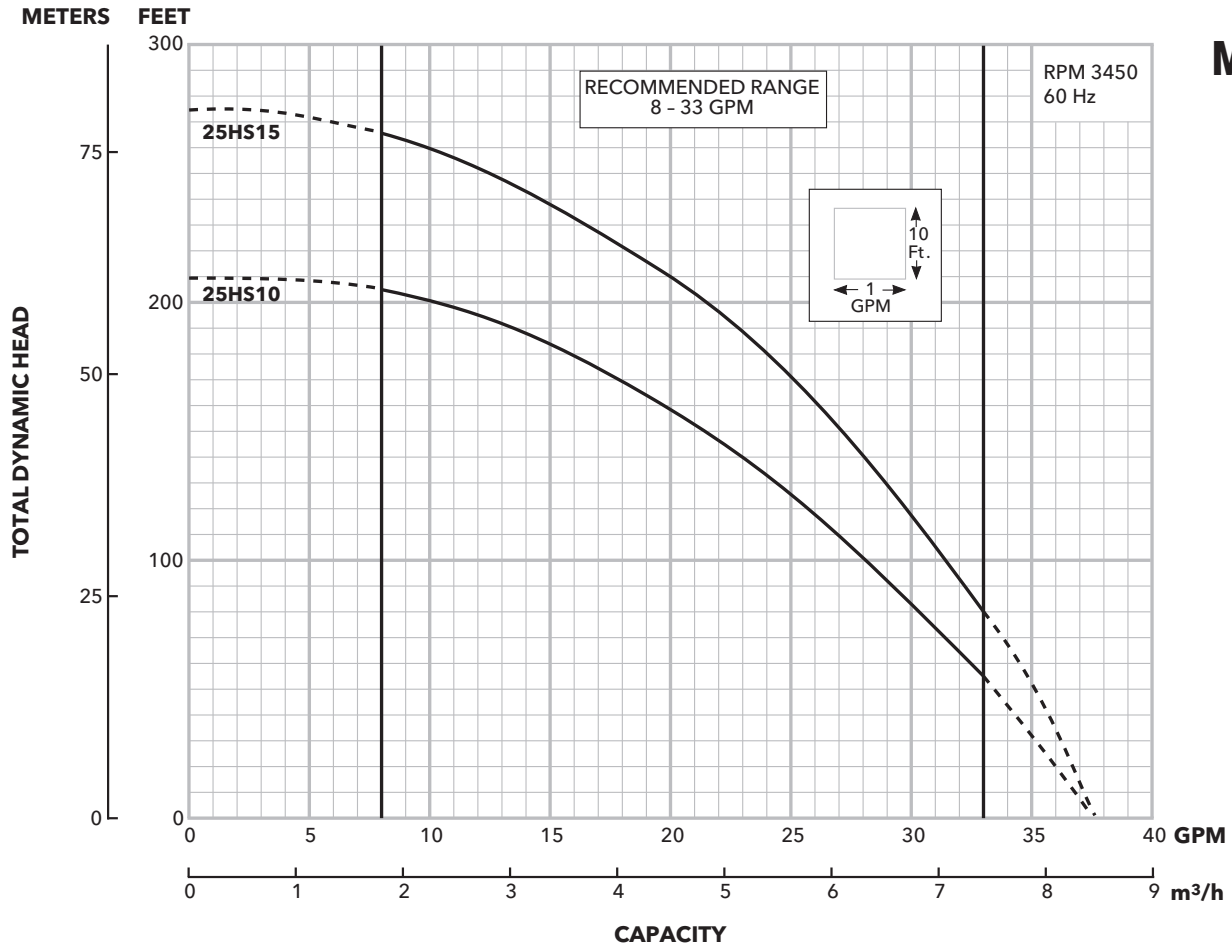

Xylem |'zīləm|

- 1) The tissue in plants that brings water upward from the roots;
- 2) a leading global water technology company.

We're a global team unified in a common purpose: creating innovative solutions to meet our world's water needs. Developing new technologies that will improve the way water is used, conserved, and re-used in the future is central to our work. We move, treat, analyze, and return water to the environment, and we help people use water efficiently, in their homes, buildings, factories and farms. In more than 150 countries, we have strong, long-standing relationships with customers who know us for our powerful combination of leading product brands and applications expertise, backed by a legacy of innovation.

For more information on how Xylem can help you, go to www.xylem.com



Xylem Inc.
2881 East Bayard Street Ext., Suite A
Seneca Falls, NY 13148
Phone: (866) 325-4210
Fax: (888) 322-5877
www.gouldswatertechnology.com

Goulds is a registered trademark of Goulds Pumps, Inc. and is used under license.
CentriPro is a trademark of Xylem Inc. or one of its subsidiaries.
Noryl and Lexan are trademarks of GE Plastic.
© 2015 Xylem Inc. B5-25HS R1 July 2015